

SMART kapp

USER'S GUIDE

KAPP42 | KAPP84

Was this document helpful?
smarttech.com/docfeedback/170769

SMART[®]

Trademark notice

DVIT, kapp, smarttech, the SMART logo and all SMART taglines are trademarks or registered trademarks of SMART Technologies ULC in the U.S. and/or other countries. Apple, App Store, iPhone and iPad are trademarks of Apple Inc., registered in the U.S. and other countries. Android and Google Play are trademarks of Google Inc. The Android robot is reproduced or modified from work created and shared by Google and used according to terms described in the Creative Commons 3.0 Attribution License. The Bluetooth word mark is owned by the Bluetooth SIG, Inc. and any use of such marks by SMART Technologies ULC is under license. All other third-party product and company names may be trademarks of their respective owners.

Copyright notice

© 2018 SMART Technologies ULC. All rights reserved. No part of this publication may be reproduced, transmitted, transcribed, stored in a retrieval system or translated into any language in any form by any means without the prior written consent of SMART Technologies ULC. Information in this manual is subject to change without notice and does not represent a commitment on the part of SMART.

This product and/or use thereof is covered by one or more of the following U.S. patents:

www.smarttech.com/patents

09/2018

Important information

WARNING

- The capture board includes instructions for installation on metal and wood stud walls and certain masonry wall types only. A SMART hardware kit is available for these types of installation. In the event that you need to install the board on reinforced concrete walls, walls with plaster lath finishing or other types of walls, refer to your local building authority for instructions, recommendations and safe work practices.
 - Do not open or disassemble the board. You risk electrical shock from the high voltage inside the casing. Opening the casing also voids the warranty.
 - Ensure that any cables that cross the floor to the board are properly bundled and marked to avoid a trip hazard.
 - Ensure your installation complies with local building and electrical codes.
 - Failure to follow the installation instructions shipped with the board could result in injury and product damage which may not be covered by the warranty.
 - To reduce the risk of fire or electric shock, do not expose the board to rain or moisture.
 - Use SMART supplied mounting hardware or hardware that is designed to properly support the weight of the capture board.
 - Use the power cable provided with the capture board. If a power cable is not supplied with the capture board, please contact your supplier. Use only power cables that match the AC voltage of the power outlet and that comply with your country's safety standards.
 - Do not place any heavy objects on the power cable. Damage to the cable could cause shock, fire or product damage which may not be covered by the warranty.
-

Federal Communication Commission interference statement

This device complies with Part 15 of the FCC Rules. Operation is subject to the following two conditions: (1) This device may not cause harmful interference, and (2) this device must accept any interference received, including interference that may cause undesired operation.

IMPORTANT INFORMATION

This equipment has been tested and found to comply with the limits for a Class A digital device, pursuant to Part 15 of the FCC Rules. These limits are designed to provide reasonable protection against harmful interference in a residential installation. This equipment generates, uses and can radiate radio frequency energy and, if not installed and used in accordance with the instructions, may cause harmful interference to radio communications. However, there is no guarantee that interference will not occur in a particular installation. If this equipment does cause harmful interference to radio or television reception, which can be determined by turning the equipment off and on, the user is encouraged to try to correct the interference by one of the following measures:

- Reorient or relocate the receiving antenna.
- Increase the separation between the equipment and receiver.
- Connect the equipment into an outlet on a circuit different from that to which the receiver is connected.
- Consult the dealer or an experienced radio/TV technician for help.

FCC Caution: Any changes or modifications not expressly approved by the party responsible for compliance could void the user's authority to operate this equipment.

This transmitter must not be co-located or operating in conjunction with any other antenna or transmitter.

5.15–5.25 GHz frequency band operation is restricted to indoor use only. Outdoor operations in the 5150~5250 MHz are prohibited.

Radiation exposure statement

This equipment complies with FCC radiation exposure limits set forth for an uncontrolled environment. This equipment should be installed and operated with minimum distance 20 cm between the radiator and your body.

Note: The country code selection is for the non-U.S. model only and is not available to all U.S. models. Per FCC regulations, all Wi-Fi products marketed in U.S. must be fixed to U.S. operation channels only.

Innovation, Science and Economic Development Canada

This device complies with RSS-247 of the ISED. Operation is subject to the following two conditions: (1) This device may not cause harmful interference, and (2) this device must accept any interference received, including interference that may cause undesired operation.

Cet appareil est conforme à la norme ISED CNR-247 pour les appareils radio agréés. Son fonctionnement est sujet aux deux conditions suivantes: (1) le dispositif ne doit pas produire de brouillage préjudiciable, et (2) ce dispositif doit accepter tout brouillage reçu, y compris un brouillage susceptible de provoquer un fonctionnement indésirable.

Caution

(i) the device for operation in the band 5150-5250 MHz is only for indoor use to reduce the potential for harmful interference to co-channel mobile satellite systems;

(ii) the maximum antenna gain permitted for devices in the bands 5250-5350 MHz and 5470-5725 MHz shall comply with the e.i.r.p. limit; and

(iii) the maximum antenna gain permitted for devices in the band 5725-5825 MHz shall comply with the e.i.r.p. limits specified for point-to-point and non point-to-point operation as appropriate.

(iv) Users should also be advised that high-power radars are allocated as primary users (i.e., priority users) of the bands 5250-5350 MHz and 5650-5850 MHz and that these radars could cause interference and/or damage to LE-LAN devices.

Avertissement

Le guide d'utilisation des dispositifs pour réseaux locaux doit inclure des instructions précises sur les restrictions susmentionnées, notamment :

IMPORTANT INFORMATION

- (i) les dispositifs fonctionnant dans la bande 5 150-5 250 MHz sont réservés uniquement pour une utilisation à l'intérieur afin de réduire les risques de brouillage préjudiciable aux systèmes de satellites mobiles utilisant les mêmes canaux;
- (ii) le gain maximal d'antenne permis pour les dispositifs utilisant les bandes 5 250-5 350 MHz et 5 470-5 725 MHz doit se conformer à la limite de p.i.r.e.;
- (iii) le gain maximal d'antenne permis (pour les dispositifs utilisant la bande 5 725-5 825 MHz) doit se conformer à la limite de p.i.r.e. spécifiée pour l'exploitation point à point et non point à point, selon le cas.
- (iv) De plus, les utilisateurs devraient aussi être avisés que les utilisateurs de radars de haute puissance sont désignés utilisateurs principaux (c.-à-d., qu'ils ont la priorité) pour les bandes 5 250-5 350 MHz et 5 650-5 850 MHz et que ces radars pourraient causer du brouillage et/ou des dommages aux dispositifs LAN-EL.

Radiation exposure statement

This equipment complies with IC radiation exposure limits set forth for an uncontrolled environment. This equipment should be installed and operated with minimum distance 20 cm between the radiator and your body.

Déclaration d'exposition aux radiations

Cet équipement est conforme aux limites d'exposition aux rayonnements IC établies pour un environnement non contrôlé. Cet équipement doit être installé et utilisé avec un minimum de 20 cm de distance entre la source de rayonnement et votre corps.

EU Declaration of Conformity

Hereby, SMART Technologies ULC declares that the radio equipment type Dry Erase Whiteboard, Kapp42 and Kapp84 is in compliance with Directive 2014/53/EU. The full text of the EU declaration of conformity is available at the following internet address: www.smarttech.com/compliance

Warning: This equipment is compliant with Class A of CISPR 32. In a residential environment this equipment may cause radio interference.

The frequency band and the maximum transmitted power in EU are listed below:

2400MHz - 2483.5MHz: 17dBm (EIRP)

Caution: This equipment complies with EU radiation exposure limits set forth for an uncontrolled environment. This equipment should be installed and operated with minimum distance 20cm between the radiator and your body.

Contents

Important information	i
Federal Communication Commission interference statement	i
Innovation, Science and Economic Development Canada	ii
EU Declaration of Conformity	iii
Chapter 1: Welcome	1
About this guide	1
About the SMART kapp 42 board	2
About the SMART kapp 84 board	3
About the SMART kapp app	4
Other documentation and resources	5
Chapter 2: Using the SMART kapp app	7
Installing the app and starting it for the first time	7
Connecting and disconnecting the app	9
Writing, erasing and viewing notes	12
Saving and working with snapshots	13
Sharing sessions	18
Chapter 3: Maintaining the SMART kapp board	23
Cleaning the SMART kapp board	23
Transporting the SMART kapp board	26
Replacing the markers and eraser	26
Chapter 4: Troubleshooting	29
What the indicator lights mean	29
Troubleshooting the app	33
Appendix A: Hardware environmental compliance	35
Waste Electrical and Electronic Equipment (WEEE)	35
More information	35

Chapter 1

Welcome

About this guide	1
About the SMART kapp 42 board	2
SMART kapp board	2
Dry erase markers and eraser	2
Mounting bracket and hardware	3
About the SMART kapp 84 board	3
SMART kapp board	4
Dry erase markers and eraser	4
Mounting bracket and hardware	4
About the SMART kapp app	4
Other documentation and resources	5
Specifications	5
Installation instructions	5
Tutorial and Help	5
Training	5
Frequently asked questions	5
Security information	5
Support center and knowledge base	6

This chapter introduces you to your SMART kapp® board and this guide.

About this guide

This guide explains how to use your SMART kapp board. It includes the following information:

- How to use your board and the SMART kapp app
- How to maintain your board for years of use
- How to troubleshoot issues with your board

This guide is intended for individuals who use and maintain the board. Other documentation and resources are available for individuals who install the board.

About the SMART kapp 42 board

You can use the SMART kapp 42 board to collaborate with others in a simple but powerful way. Write and draw on the board as you would on a regular dry erase board. You can then connect a Bluetooth®-enabled mobile device to the board by scanning a Quick Response (QR) code or by tapping the Near Field Communication (NFC) tag. When you connect your mobile device for the first time, you're directed to the Apple App Store™ or Google Play™ store to download the SMART kapp app. After you download and install the app, you can use it to connect to the board and share content with others.

The SMART kapp 42 board consists of the following components:

- SMART kapp board
- Dry erase markers and eraser
- Mounting bracket and hardware

SMART kapp board

The SMART kapp board features SMART's proprietary DVIT® (Digital Vision Touch) technology on a 42" (107 cm) writing surface. DVIT technology captures the notes you make on the board using the dry erase markers and eraser. The board's Bluetooth 4.0 wireless technology (for Apple mobile devices) or Bluetooth 2.1 + EDR wireless technology (for Android™ mobile devices) then transfers your notes as a digital image to a connected mobile device. Alternatively, you can save your notes to a FAT-formatted USB drive by connecting it to the board's USB 2.0 Type-A receptacle. You can also use the board's standard 500 mA USB 2.0 Type-A receptacle to charge your smart phone.

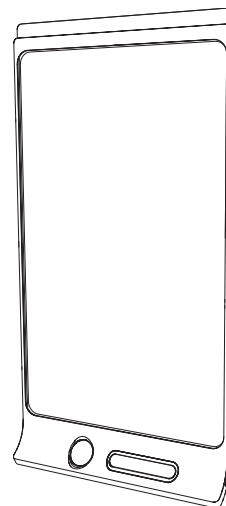

Dry erase markers and eraser

The SMART kapp board comes with three dry erase markers and a special eraser designed to work with the board.

The board includes holders for one marker and the eraser as well as a storage area (on the back of the board) for the other two markers.

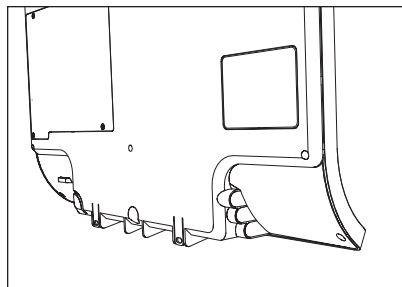
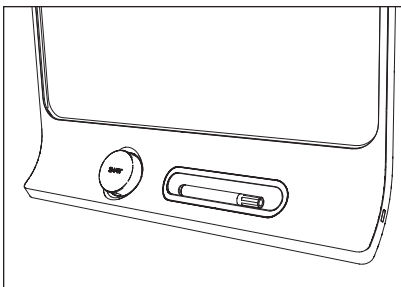

Mounting bracket and hardware

You can use the supplied mounting bracket and hardware to mount the SMART kapp board on a wall. Alternatively, you can mount the board using a standard VESA® 400 mm × 400 mm mounting bracket.

About the SMART kapp 84 board

You can use the SMART kapp 84 board to collaborate with others in a simple but powerful way. Write and draw on the board as you would on a regular dry erase board. Two people can draw at the same time. You can then connect a Bluetooth-enabled mobile device to the board by scanning a Quick Response (QR) code or by tapping the Near Field Communication (NFC) tag. When you connect your mobile device for the first time, you're directed to the Apple App Store or Google Play store to download the SMART kapp app. After you download and install the app, you can use it to connect to the board and share content with others.

The SMART kapp 84 board consists of the following components:

- SMART kapp board
- Dry erase markers and eraser
- Mounting bracket and hardware

SMART kapp board

The SMART kapp board features SMART's proprietary DViT technology on a 84" (213 cm) writing surface. DViT technology captures the notes you make on the board using the dry erase markers and eraser. The board's Bluetooth 4.0 wireless technology (for Apple mobile devices) or Bluetooth 2.1 + EDR wireless technology (for Android mobile devices) then transfers your notes as a digital image to a connected mobile device. Alternatively, you can save your notes to a FAT-formatted USB drive by connecting it to the board's USB 2.0 Type-A receptacle. You can also use the board's standard 500 mA USB 2.0 Type-A receptacle to charge your smart phone.

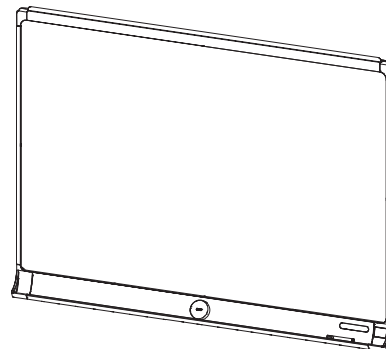

Dry erase markers and eraser

The SMART kapp board comes with six dry erase markers and a special eraser designed to work with the board.

Mounting bracket and hardware

You can use the supplied mounting bracket and hardware to mount the SMART kapp board on a wall. Alternatively, you can mount the board using a standard VESA 600 mm × 400 mm mounting bracket.

About the SMART kapp app

The SMART kapp app enables you to connect your mobile device to a SMART kapp board and then do the following:

- View notes you write on the board on your mobile device
- Save and export your notes
- Start a session and invite others to join and collaborate

Other documentation and resources

SMART provides an extensive library of documentation and resources for the SMART kapp board.

Specifications

The specifications include the board's dimensions, weight, recommended operating and storage temperatures, power specifications and other important information:

Model	Specifications
SMART kapp 42 board	smarttech.com/kb/170770
SMART kapp 84 board	smarttech.com/kb/170868

Installation instructions

The board comes with installation instructions that explain how to mount the board using the supplied mounting bracket and hardware.

If you misplaced the installation instructions, you can download them:

Model	Installation instructions
SMART kapp 42 board	smarttech.com/kb/170768
SMART kapp 84 board	smarttech.com/kb/170870

Tutorial and Help

When you first start the SMART kapp app on your mobile device, a tutorial opens. This tutorial explains how to connect your mobile device to the board and share and save your notes (see *Installing the app and starting it for the first time* on page 7).

Training

The SMART training website (smarttech.com/trainingforbusiness) includes an extensive library of training resources you can refer to when learning how to use the board.

Frequently asked questions

For answers to common questions about the board, see *SMART kapp board frequently asked questions* (smarttech.com/kb/170793).

Security information

For information about the SMART kapp security features, see *SMART kapp security information* (smarttech.com/kb/170892).

Support center and knowledge base

The Support center (smartkapp.com/support) includes documentation and a knowledge base that you can refer to when performing maintenance on the board or troubleshooting issues with the board.

Chapter 2

Using the SMART kapp app

Installing the app and starting it for the first time	7
Installing the app	8
Starting the app for the first time	9
Connecting and disconnecting the app	9
Connecting	9
Connecting by QR code	10
Connecting by NFC	10
Connecting by Board ID	11
Disconnecting	11
Writing, erasing and viewing notes	12
Writing and erasing notes	12
Viewing notes	13
Saving and working with snapshots	13
Saving snapshots to the app	14
Viewing snapshots	14
Exporting snapshots	15
Deleting snapshots	16
Sharing sessions	18
Sharing sessions	18
Setting the shared session link type	19
Securing shared sessions	19
Stopping sharing	20
Connecting to another session	20

This chapter explains how to use the SMART kapp app with the SMART kapp iQ board.

Installing the app and starting it for the first time

You can download and install the SMART kapp app by visiting the Apple App Store or Google Play™, or you can install the app on your mobile device by scanning your board's QR code or by tapping its NFC tag.

The app is compatible with the following devices:

Device type	Requirements	Connection options
Apple	iOS 8.1 or later operating system software 50 MB of storage iPhone 4S or later Third generation iPad or later First generation iPad mini or later Fifth generation iPod touch or later	Scan the board's unique QR code Enter the board's ID
Android	Android 4.4.4 (KitKat) or later operating system 50 MB of storage (internal or SD card) 1024 MB of RAM 720p or better screen resolution Bluetooth 2.1 + EDR NFC (recommended) 3 megapixel or better rear-facing camera (recommended)	Scan the board's unique QR code Tap the board's NFC tag Enter the board's ID

Installing the app

To install the app

1. Do one of the following:
 - Visit the Apple App Store or Google Play on your mobile device and search for **SMART kapp**.
 - Start the QR code scanning app on your mobile device, and then hold your mobile device's rear-facing camera over your board's QR code to scan it.
 - Enable NFC in your mobile device's settings (if it isn't already enabled), and then hold your mobile device near your board's NFC tag  (Android mobile devices only).

The Apple App Store or Google Play opens.

2. Download and install the app.

Starting the app for the first time

To start the app for the first time

1. Start the SMART kapp app on your mobile device.
The app tutorial appears.
2. Use the swipe gestures to progress through the screens of the tutorial.



Previous screen

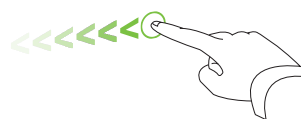



Next screen

3. Tap **Close** when you have completed the tutorial.

The app home screen appears.

TIP

If you want to view the tutorial again, do the following:

- On an Apple mobile device, tap **Settings**  on the app home screen and then select **Tutorial**.
 - On an Android mobile device, tap **Menu** , select **Settings**, and then select **Tutorial**.
-

Connecting and disconnecting the app

The SMART kapp app enables you to connect your mobile device to a SMART kapp board and then do the following:

- View notes you write on the board on your mobile device
- Save and export your notes
- Start a session and invite others to join and collaborate

Connecting

Start a session by connecting your mobile device to a SMART kapp board.

NOTE

To get the best experience while using the SMART kapp app and to access all the latest features, make sure you have the latest version of the app on your mobile device. Some features listed in this documentation may not be available with older versions of the app.

Connecting by QR code

A QR code is a type of bar code. If your mobile device has a rear-facing camera and a QR code scanning app, you can scan QR codes like the one on the board. Your mobile device then executes the QR codes' commands. Typically, QR codes' commands display messages or open web pages.



To connect by QR code

1. Start the SMART kapp app on your mobile device.
2. Hold your mobile device's rear-facing camera still over the board's QR code so that the QR code appears in the center of the app screen.

The app connects your mobile device to the board.

TIP

If the app doesn't connect your mobile device to the board, move your mobile device closer to or farther away from the board so that the app can capture the QR code.

NOTE

Some Android mobile devices require you to accept a pairing request to connect to the board. Swipe down on the screen to access the notification drawer and accept the pairing request.



Connecting by NFC

NFC is a wireless technology that enables you to connect your Android mobile device and another device, such as the board, by holding your mobile device a short distance from (or "tapping") the other device.

NOTE

Currently, you are unable to connect the board to Apple mobile devices using the mobile device's NFC support.

TIP

Refer to your mobile device's documentation for the location of its NFC radio. When connecting your mobile device to the board, you might need to move the mobile device back and forth until its NFC radio detects the board's NFC tag.

To connect by NFC

1. Enable NFC in your mobile device's settings (if it isn't already enabled).
2. Hold your mobile device near the board's NFC tag .

The app starts and connects your mobile device to the board.

Connecting by Board ID

Each board has a unique Board ID that you can use to connect your mobile device manually.

To connect by Board ID

1. Locate the board's 10-character ID.
-

TIP

The Board ID is located by the QR code.

2. Start the SMART kapp app on your mobile device.
3. On an Apple mobile device, tap **Settings** .

OR

On an Android mobile device, tap **Menu** , and select **Settings**.

4. Tap **Advanced**, and then tap **Connect Manually**.

The *Manually Connect* screen appears.

5. Type the Board ID in the *Enter ID* box.
6. Tap **Connect**.

The app connects your mobile device to the board.

Disconnecting

The app disconnects from the current session in the following situations:

- When you close the app
- Automatically after a period of non-use

- When the board is outside of your mobile device's Bluetooth communication range, which is approximately 33' (10 m)

NOTE

- When you connect an Android mobile device to the board, an icon appears in the notification area. This icon indicates when the mobile device is connected to the board:



Connected



Disconnected

- When you disconnect, the SMART kapp app takes a final snapshot of the board if the content has changed since the last snapshot.

To disconnect the app manually

Tap **Disconnect** in the top left corner of the SMART kapp app screen, and then tap **Disconnect**.

OR

Hold **Bluetooth**  on the board until it turns solid red.

Writing, erasing and viewing notes

You can write and erase notes on the SMART kapp board just like you do on a traditional dry erase board. You can view your notes on the board or in the app.

Writing and erasing notes

You can write and erase notes on the board just like you do on a traditional dry erase board. To get the best performance out of the board, follow these best practices:

- Wait for the icons on the board to stop flashing before you begin writing.
- Write and draw using the markers provided with your board or a third-party marker recommended by SMART. For a list of recommended third-party markers see *Replacing the markers and eraser* on page 26.
- Hold the pen away from the tip and at a right (90°) angle to the board's surface.
- Ensure your palm, hand, arm and any loose clothing doesn't touch the board while you're writing.
- Write clearly with large text and spaced out ink strokes.
- Avoid writing too close to the edges and corners of the board.

- While connected with the app, use only the eraser provided with the board.
- While erasing, hold the eraser flat against the board.
- Clean the eraser and board periodically following the instructions provided in this guide (see *Cleaning the SMART kapp board* on page 23).

Viewing notes

During a session, you can view the notes you've written on the board on your mobile device. As you write or erase notes, the changes appear on your mobile device automatically.

By default, your mobile device displays the board's entire writing surface. You can use gestures to zoom in, zoom out and pan:

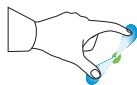

Zoom in



Zoom out



Pan

NOTE

As you zoom in or out, grid lines appear on the writing surface to indicate the level of magnification.

Saving and working with snapshots

As you write notes on a SMART kapp board, you might want to save snapshots of your notes from time to time during the session.

After you save snapshots, you can do the following:

- View the snapshots
- Export the snapshots as JPEG or PDF files
- Delete the snapshots

Saving snapshots to the app

To save a snapshot

1. Start or connect to a session (see *Connecting and disconnecting the app* on page 9).
2. Press **Capture**  on the board.

OR

Press **Capture**  in the app.

The app saves a snapshot of your notes.

NOTES

- The *Sessions*  button in the bottom-right corner of the screen indicates how many snapshots have been saved in the current session.
 - Notes are always saved as black ink.
-

Viewing snapshots

When you save a snapshot, the app saves it to your session's library. Access your current session or a previous session's library to view your saved snapshots.

TIP

You can use the zoom in, zoom out and pan gestures when viewing snapshots (see *Viewing notes* on the previous page).

To view snapshots in the current session

1. Take one or more snapshots in the current session (see *Saving snapshots to the app* above).
2. On an Apple mobile device, tap **Sessions** .

OR

On an Android mobile device, tap **Sessions** .

The *Sessions* screen appears.

3. Tap a snapshot's thumbnail image to view it.

To view snapshots in previous sessions

1. If you're currently in a session, disconnect (see *Disconnecting* on page 11).

2. On an Apple mobile device, tap **Sessions** .

OR

On an Android mobile device, tap **Sessions** .

The *Sessions* screen appears.

3. Select a session to view the snapshots saved for that session.

The session's snapshot library appears.

4. Select a snapshot's thumbnail image to view it.

Exporting snapshots

If you want to share any snapshots of your notes, you can use the app to export them and then use a third-party app on your phone to share your snapshots as a PDF or JPEG file.

To export a snapshot

1. View the snapshot you want to export (see *Viewing snapshots* on the previous page).

2. On an Apple mobile device, tap **Export** , and then select **Save to Camera Roll, Share as PDF** or a cloud service.

OR

On an Android mobile device, tap **Menu** , and then select **Save to Camera Roll, Share as PDF** or a cloud service.

3. If you selected **Share as Image** or **Share as PDF**, select the app you want to use to share the snapshot.

4. Use the selected app to share the snapshot.

To export all snapshots saved in the current session

1. Save one or more snapshots in the current session (see *Saving snapshots to the app* on the previous page).

2. Tap **Sessions** .

The *Sessions* screen appears.

3. On an Apple mobile device, tap **Export** .

OR

On an Android mobile device, tap **Menu** , and then select **Share as Image** or **Share as PDF**.

4. Select the app you want to use to export the snapshots.
5. Use the selected app to export the snapshots.

To export all snapshots saved in a previous session

1. If you're currently in a session, disconnect (see *Disconnecting* on page 11).
2. On an Apple mobile device, tap **Sessions** .

OR

On an Android mobile device, tap **Sessions** .

The *Sessions* screen appears.

3. Select a session to view the snapshots saved for that session.

The session's snapshot gallery appears.

4. On an Apple mobile device, tap **Export** .

OR



On an Android mobile device, tap **Menu** , and then select **Share as PDF**.

5. Select the app you want to use to export the snapshots.
6. Use the selected app to export the snapshots.

Deleting snapshots



You can either delete snapshots individually or delete an entire session and all of its saved snapshots.

To delete a snapshot from a previous session

1. If you're currently in a session, disconnect (see *Disconnecting* on page 11).
2. On an Apple mobile device, tap **Sessions** .
- OR
- On an Android mobile device, tap **Sessions** .
- The *Sessions* screen appears.
3. Select the session that contains the snapshot you want to delete.
The session's snapshot gallery appears.
4. Select the snapshot you want to delete.
5. Tap **Delete** , and then tap **Delete**.





To delete a previous session on an Apple mobile device

1. If you're currently in a session, disconnect (see *Disconnecting* on page 11).
2. Tap **Session** .
- The *Sessions* screen appears.
3. Select **Edit**.
4. Tap the session's **Delete**  button, and then tap **Delete**.
5. Tap **Done**.



To delete a previous session on an Android mobile device

1. If you're currently in a session, disconnect (see *Disconnecting* on page 11).
2. Tap **Sessions** .
- The *Sessions* screen appears.
3. Tap **Menu** , and then select **Select**.
4. Select the session.
5. Tap **Delete** , and then tap **Delete**.

Sharing sessions

During a session, you can use the SMART kapp app to invite up to 250 people to view your notes on their mobile or desktop devices.

NOTE

You can share notes only as long as the SMART kapp app is running on your mobile device and your mobile device is connected to a board.

Sharing sessions

When you share a session with others, they can tap or click a link to view your session in their web browsers; they don't need to install additional software or otherwise configure their devices.

Alternatively, others can choose to install the SMART kapp app on their mobile devices and use it to connect to your session.

As you make changes to your notes, others see these changes in real time. They can also zoom in or out, and save, view and export snapshots.

NOTE

- The SMART kapp web viewer supports the following browsers:

Mobile devices	Safari for iOS 8.1 or later operating system software Chrome™ for Android 39.0.2171.93 or later
Computers	Internet Explorer® 10 or later Chrome 39.0.2171.95 or later Firefox® 34.0.5 or later Safari 8.0 or later

- You can share notes only as long as the SMART kapp app is running on your mobile device and your mobile device is connected to a board.
 - You can export saved snapshots of notes without connecting your mobile device to a board (see *Exporting snapshots* on page 15).
-

To share your session



1. Connect your mobile device to a board (see *Connecting and disconnecting the app* on page 9).

2. Tap **Invite** , and then select **Send Link**.
3. Select the app you want to use to send the invitation.
4. Use the selected app to send the invitation.

Setting the shared session link type

When you invite others to join your session, the app sends them a dynamic link by default. When you use a dynamic link, the app creates a new link each time you send an invite for others to join your session. However, the app also provides you with the option of sending a static link to join your session. A static link provides a permanent link to your sessions so that the link is the same each time you send an invite. With a static link, you can send the link before meetings start to help simplify meeting startup. If you want to use a static link instead of a dynamic link, then you can change your invitation link preferences from the app's settings.



To use a static link

1. If you're currently in a session, stop sharing the session (see *Stopping sharing* on the next page).
2. On an Apple mobile device, tap **Settings** .
- OR
- On an Android mobile device, tap **Menu** , and select **Settings**.
3. Select **Sharing**, and then select **Static Link**.
4. Optionally, select **Send Link**, and then select a method to send the static link to others.

Securing shared sessions

In the SMART kapp app, you can add password security to protect your sessions before you send out a link sharing them. This means that others will have to use the password you set to join your shared session.

To use a password

1. If you're currently in a session, stop sharing the session (see *Stopping sharing* on the next page).
2. On an Apple mobile device, tap **Settings** .
- OR
- On an Android mobile device, tap **Menu** , and select **Settings**.

3. Select **Sharing**, and then select **Password**.

The *Enter Password* screen appears.

4. Select **Require a Password**.
5. Type up to 32 characters for a password.
6. Tap **OK**.

To remove the password

1. If you're currently in a session, stop sharing the session (see *Stopping sharing* below).
2. On an Apple mobile device, tap **Settings** .

OR

On an Android mobile device, tap **Menu** , and select **Settings**.

3. Select **Sharing**, and then select **Password**.

The *Enter Password* screen appears.

4. Deselect **Require a Password**.
5. Tap **Done**.

Stopping sharing

You can stay connected to the board but stop sharing the current session.

To stop sharing a session

1. Tap **Invite** , and then tap **Options**.
2. Tap **Stop Sharing**.
3. Tap **Stop Sharing** to end sharing the session.

Connecting to another session

If another person shares a session with you, you can connect to that session using the SMART kapp app on your mobile device. Once connected, you can do everything in the other person's session that you can do in your own sessions:

- Write and erase notes
- View notes

- Save snapshots of notes
- Share snapshots

To connect to another session on a mobile device

1. From your mobile device, open the email that the session's host sent you.
2. Tap the link in the email.

If you have the SMART kapp app installed, the app opens and displays the notes the other person is sharing.

NOTE

If the SMART kapp app isn't installed on your mobile device, follow the on-screen instructions to install it.

To connect to another session on a desktop

1. From your computer, open the email that the session's host sent you.
2. Click the link in the email.

The SMART kapp app opens in your computer's default browser, displaying the notes the other person is sharing.

CHAPTER 2
USING THE SMART KAPP APP

Chapter 3

Maintaining the SMART kapp board

Cleaning the SMART kapp board	23
Recommended cleaners	23
Cleaning the writing surface	24
Cleaning the frame and corner sensors	24
Cleaning the eraser	25
Transporting the SMART kapp board	26
Replacing the markers and eraser	26
Purchasing replacement markers and erasers from the Store for SMART Parts	26
Purchasing replacement markers from other sources	27

This chapter explains how to maintain the SMART kapp board for years of use.

Cleaning the SMART kapp board

With proper care, the SMART kapp board will provide years of trouble-free service. SMART recommends you clean the board monthly to help ensure optimal performance.

Recommended cleaners

To clean the board's writing surface, frame and cameras, use one of the following cleaners:

- Water
- Dry erase cleaners
- EXPO® Whiteboard Care cleaner
- Windex® glass cleaner (for SMART kapp 42 only)
- Isopropyl alcohol

CAUTION

Do not use whiteboard conditioners to clean the writing surface.

Cleaning the writing surface

Follow the instructions below to clean your board's writing surface.

To clean the writing surface

1. Disconnect the board from its power source.
2. Spray a small amount of water or cleaner onto a clean lint-free cloth or paper towel.
3. Clean the board's surface.

 **CAUTION**

As you clean the writing surface:

- Do not spray the cleaner directly onto the board.
 - Do not allow excess cleaner to flow into the frame's corners where the cameras are located.
 - Do not allow excess cleaner to flow onto the reflective tape that lines the inside of the frame.
-

Cleaning the frame and corner sensors

The SMART kapp board uses cameras located in the corners of the frame and reflective tape along the inside of the frame to capture your writing. Although the cameras are protected by windows, dust or dry erase residue can build up on frame's reflective tape and in the corners, impairing the board's performance.

TIP

SMART recommends that you clean the corner sensors last in case the previous cleaning instructions left debris on the sensors.

To clean the frame's reflective tape and corners—Method 1

1. Disconnect the board from its power source.
2. Carefully vacuum the areas where dust and dry erase residue have built up.

 **CAUTION**

Do not use compressed air to clean the corner cameras or the frame.

To clean the frame's reflective tape and corners—Method 2

1. Disconnect the board from its power source.
2. Spray a small amount of water or cleaner onto a clean lint-free cloth or paper towel.

TIP

When you clean the windows in the corners, use a cotton swab rather than a cloth or paper towel to get any residue and dust out of the smaller areas.

CAUTION

Do not use compressed air to clean the corner cameras or the frame.

3. Starting at one of the corners, gently wipe the camera's window and then continue to gently wipe toward the center along the reflective tape. This helps to avoid wiping dry erase residue and dust onto the corner sensors as you clean.

CAUTION

As you clean, do not apply too much pressure. Applying too much pressure could damage the reflective tape or cameras.

4. Repeat the previous step for each corner. Pay particular attention to the bottom corners, as they're the most likely to collect dust and debris.

Cleaning the eraser

Over time, the eraser can become less effective as its felt edge collects dry erase ink residue. To clean the eraser, use the following instructions.

To clean the eraser's felt

1. Rinse the eraser's felt edge under cold running water.
2. While wearing gloves, apply a mild soap or detergent and rub the felt with your fingers.
3. Rinse the felt thoroughly under cold running water.
4. Remove excess water by pressing the felt against a towel or paper towel.
5. Allow the felt to air dry completely.

Transporting the SMART kapp board

When you need to uninstall the SMART kapp board from its mobile stand or wall mount and transport it to another location, make sure you use the original packaging to repack the board. This packaging was designed with optimal shock and vibration protection. If the original packaging isn't available, you can purchase the same packaging directly from your authorized SMART reseller (smarttech.com/where).

CAUTION

Transport the board only in original or replaced packaging. Transporting the board without correct packaging voids the warranty and could lead to product damage.

For instructions on how to repack the board for transportation, see [How to package a SMART kapp 42 for return](#).

Replacing the markers and eraser

The SMART kapp 42 board comes with three dry erase markers and one eraser.

The SMART kapp 84 board comes with six dry erase markers and one eraser.

Purchasing replacement markers and erasers from the Store for SMART Parts

If you need to replace the dry erase markers or eraser, visit the Store for SMART Parts (smarttech.com/Support/PartsStore).

Purchasing replacement markers from other sources

Alternatively, you can also replace the dry erase markers with third-party dry erase markers. The barrel of third-party dry erase markers can be any length and diameter, but the tip and nib must be within the following dimensions:

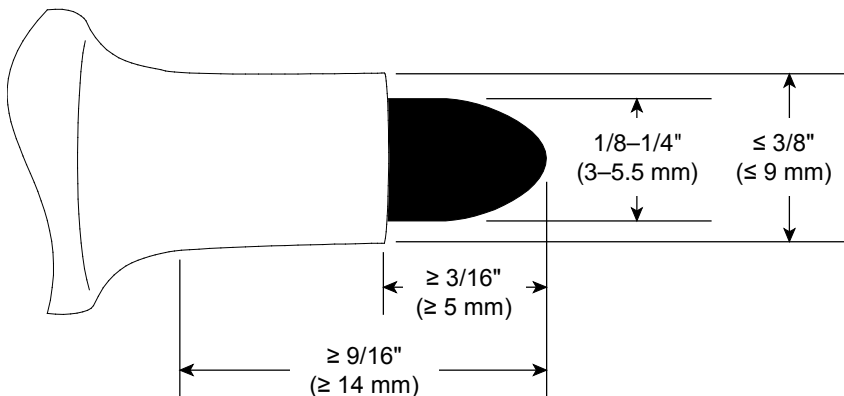

For best results, SMART recommends these third-party replacement markers:

- BIC® Magic Marker® dry erase liquid markers, fine tip
- EXPO® low odor fine tip dry erase markers
- Staples® Remarx™ dry erase markers, bullet tip
- Melissa & Doug® dry erase markers

CAUTION

The following pens are not recommended for use with the board.

- BIC Great Erase Grip® dry erase markers
 - Board Dudes®
 - Liqui-Mark®
 - Quartet®
-

Chapter 4

Troubleshooting

What the indicator lights mean	29
Startup	29
After startup	30
Troubleshooting the app	33

This chapter explains how to troubleshoot common issues with the SMART kapp board and the SMART kapp app.

What the indicator lights mean

SMART kapp boards have four indicator lights. The indicator lights are in the bottom-right corner of SMART kapp 42 boards and on the pen ledge of SMART kapp 84 boards.

Startup

When you first connect the board to a power source, the indicator lights turn on and off in the following order until the board is ready for use:



- Status
- Bluetooth
- USB
- Capture

After startup

When the board is ready for use, you can use the indicator lights to see the board's status and diagnose common issues.

Light	What it means	What to do
 Status		
Off	The board isn't receiving power. The board will not capture ink, and it will also forget previously recorded ink.	Erase any ink currently on the board, then connect the board to the power supply. Wait for the status light to turn solid green before you write on the board. Contact SMART Support for assistance if the status light remains off after you connect power.
On	The board is receiving power and is working properly.	[N/A]

Light	What it means	What to do
Flashing red (after startup)	The board has detected a condition that might prevent the board from working properly.	<p>Write on the board using only compatible markers.</p> <p>Use only SMART's circular kapp eraser. Do not use a third-party eraser of a different shape or size.</p> <p>Ensure there are no obstructions to the optical capture system within the board's frame. Obstructions could include pens, erasers, note papers, or any other object resting on the frame or board surface.</p> <p>Erase all the ink and disconnect the board from power. Wait 30 seconds and reconnect power.</p> <p>Clean the writing surface and frame using the cleaning instructions in the user guide. Dust and dirt buildup can prevent the optical capture system from working correctly.</p> <p>Make sure no external sources of infrared light, such as overhead lighting or sunlight, are shining on the board and preventing the optical capture system from working correctly.</p> <p>If the status light continues to flash, Contact SMART Support for assistance.</p>
Flashing green (SMART kapp 84 only)	The front-panel status display is waiting for information from the board's main controller.	Wait several seconds for the board's controller to finish initializing. If the status light is still flashing green after several minutes, the board might not be receiving enough power to turn on fully. Connect the board to a different power source, and/or replace the power adapter.

Light	What it means	What to do
 Bluetooth		
Off	The board isn't connected to a mobile device. The board was previously connected to a mobile device but the SMART kapp app on the mobile device isn't running or the device has moved out of the board's Bluetooth communication range.	If you previously connected the mobile device, ensure the SMART kapp app is running and the device is within the board's Bluetooth communication range.
Flashing	The board is connecting to a mobile device.	[N/A]
On	The board is connected to a mobile device.	[N/A]
Flashing red	The board is disconnecting from the mobile device.	[N/A]
Solid red	The board has disconnected from the mobile device.	[N/A]
 USB		
Off	The board isn't connected to a USB drive. The board doesn't recognize the connected device as a USB drive.	Connect only USB drives to the USB receptacle.
Flashing	The board is connecting to a USB drive. The board is saving a snapshot of your notes to the connected USB drive.	[N/A]
On	The board is connected to a USB drive.	[N/A]
Flashing red	The board is unable to save snapshots of your notes to the connected USB drive because the USB drive is full, is not FAT formatted or there's another problem with it.	Disconnect the USB drive, and then connect a different USB drive.
 Capture		
Off	The board isn't connected to a USB drive or a mobile device.	[N/A]

Light	What it means	What to do
Flashing	The board is saving a snapshot of your notes to the connected mobile device.	[N/A]
On	The board is connected to a USB drive or a mobile device.	[N/A]

Troubleshooting the app

The following are issues that you might encounter while using the SMART kapp app and SMART kapp board.

Your mobile device doesn't connect to the board.	<ul style="list-style-type: none"> Make sure no other mobile devices are connected to the board. (The board can connect to only one mobile device at a time.)
Your mobile device doesn't connect when you use the QR code.	<ul style="list-style-type: none"> Make sure your device's rear-facing camera is working and Bluetooth is enabled. Ensure the QR code is clean and fully visible. Position your mobile device so that your board's QR code appears in the center of the SMART kapp app screen.
Your Android mobile device doesn't connect when you use NFC.	<ul style="list-style-type: none"> Ensure your Android mobile device supports NFC. Ensure NFC and Bluetooth are enabled in your Android mobile device's settings. Position your Android mobile device as close as possible to the NFC tag on your board when connecting.
When you write on the board, your writing doesn't appear in the SMART kapp app, or extra lines or other visual noise appear in the SMART kapp app.	<ul style="list-style-type: none"> Ensure the board's cameras and frame are clean. Check for and remove any objects in the frame. Ensure your hands, arms or loose clothing aren't touching the board as you write. Write on the boards using only compatible markers. Keep your board away from bright light sources, such as direct sunlight and incandescent lighting. Download and install the latest firmware.
The SMART kapp app displays the "Object blocking frame" message.	The SMART kapp app displays this message when dirt on the board's frame obscures the sensors. To fix this, clean the board's cameras and frame.
My issue isn't listed here.	<ul style="list-style-type: none"> Download and install the latest firmware. If the issue still persists, contact SMART Support for assistance.

Appendix A

Hardware environmental compliance

SMART Technologies supports global efforts to ensure that electronic equipment is manufactured, sold and disposed of in a safe and environmentally friendly manner.

Waste Electrical and Electronic Equipment (WEEE)

Electrical and electronic equipment and batteries contain substances that can be harmful to the environment and to human health. The crossed-out wheeled bin symbol indicates that products should be disposed of in the appropriate recycling stream and not as regular waste.



More information

See smarttech.com/compliance for more information.

SMART TECHNOLOGIES

smarttech.com/support

smarttech.com/contactsupport

smarttech.com/kb/170769